

# Domabot

A quick, simple robot base design,  
perfect for classroom environments

Base Design

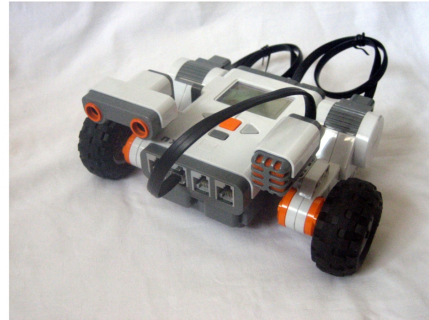

Touch Sensor  
Attachment

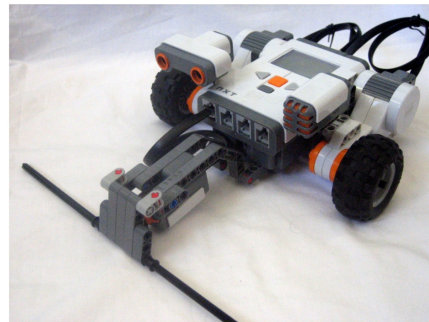

Light Sensor  
Attachment



Pen  
Attachment

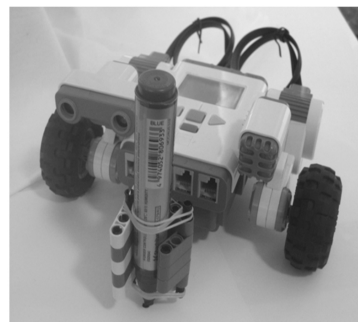

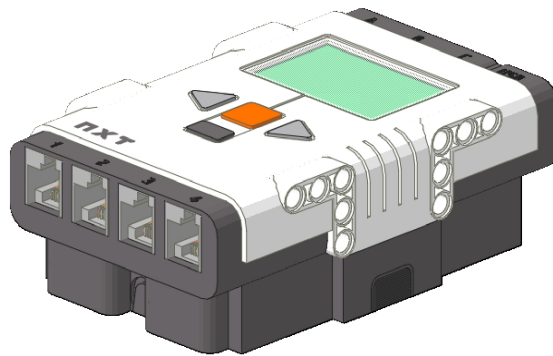
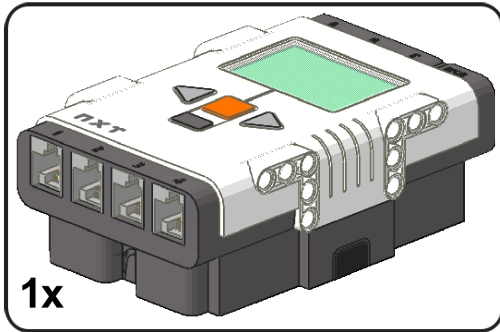

---

# Domabot - Base

Design by Damien Kee - [www.damienkee.com](http://www.damienkee.com)  
Teacher Resource Books - [www.domabotics.com/books](http://www.domabotics.com/books)

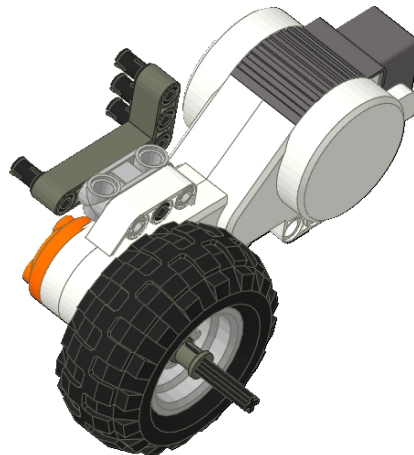
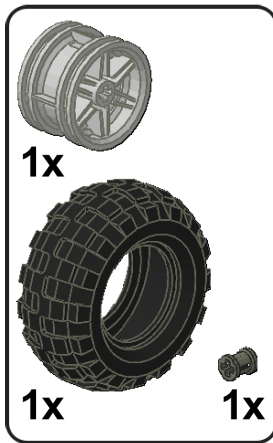
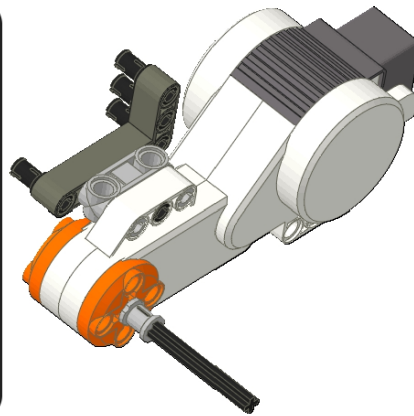
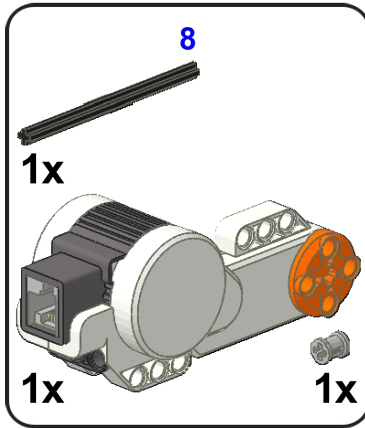
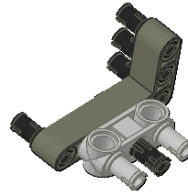
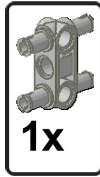
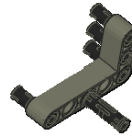
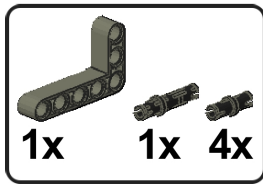

# Domabot - Base

Design by Damien Kee - [www.damienkee.com](http://www.damienkee.com)  
Teacher Resource Books - [www.domabotics.com/books](http://www.domabotics.com/books)

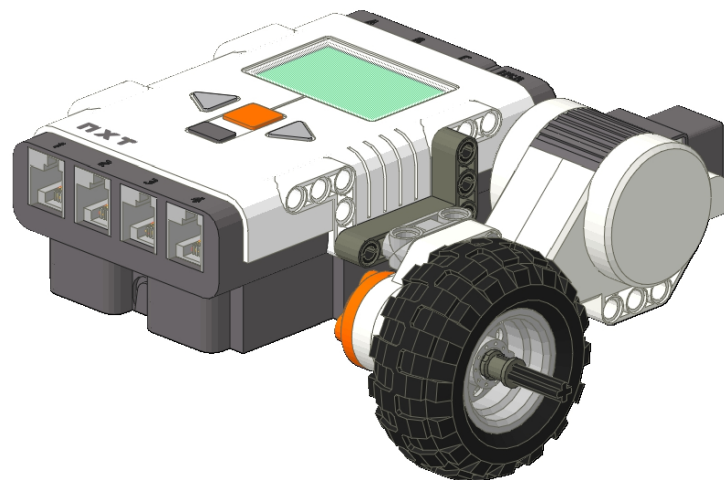

---

# Domabot - Base

Design by Damien Kee - [www.damienkee.com](http://www.damienkee.com)  
Teacher Resource Books - [www.domabotics.com/books](http://www.domabotics.com/books)



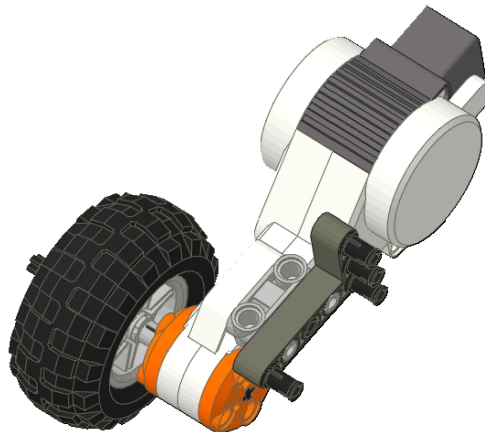
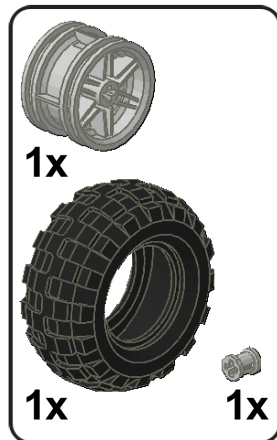
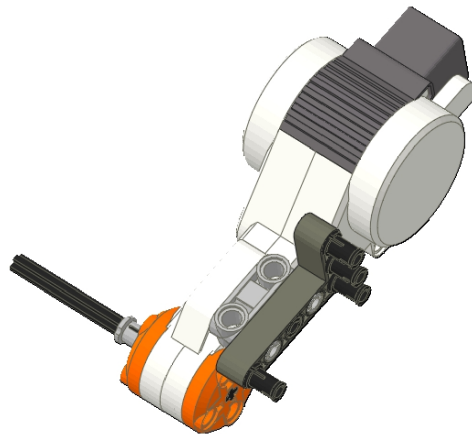
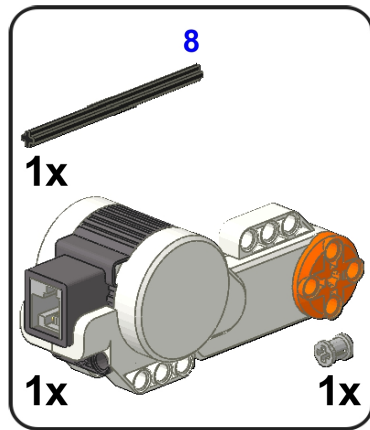
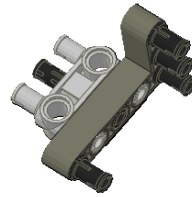
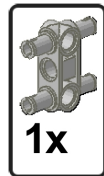
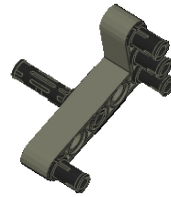
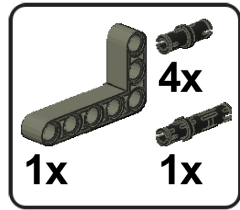

# Domabot - Base

Design by Damien Kee - [www.damienkee.com](http://www.damienkee.com)  
Teacher Resource Books - [www.domabotics.com/books](http://www.domabotics.com/books)

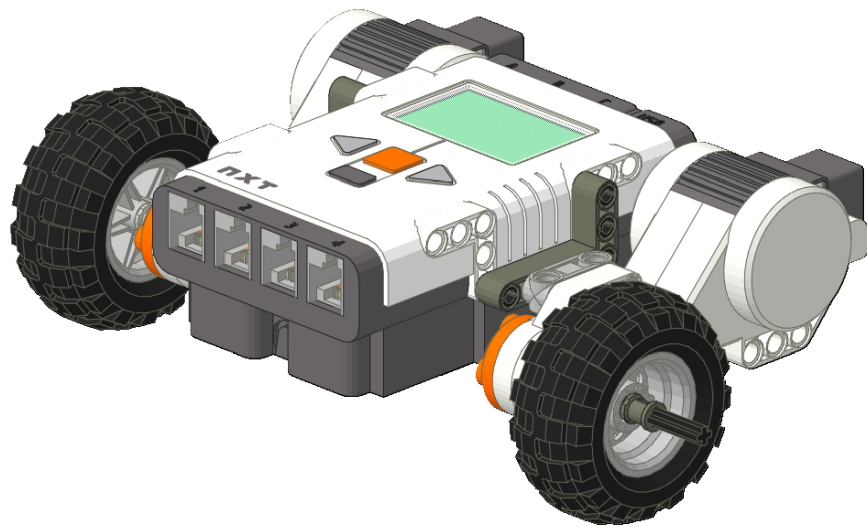

---

# Domabot - Base

Design by Damien Kee - [www.damienkee.com](http://www.damienkee.com)  
Teacher Resource Books - [www.domabotics.com/books](http://www.domabotics.com/books)

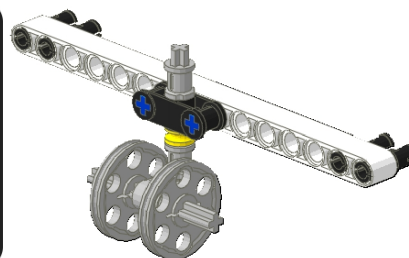
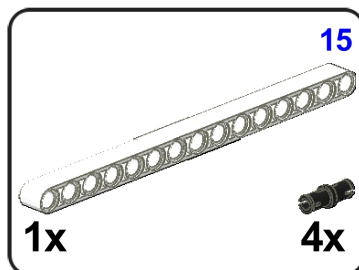
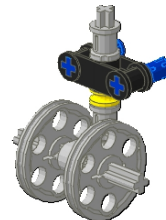
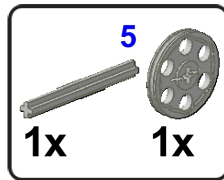
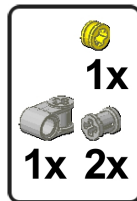
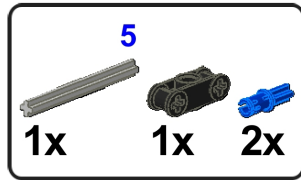

# Domabot - Base

Design by Damien Kee - [www.damienkee.com](http://www.damienkee.com)  
Teacher Resource Books - [www.domabotics.com/books](http://www.domabotics.com/books)

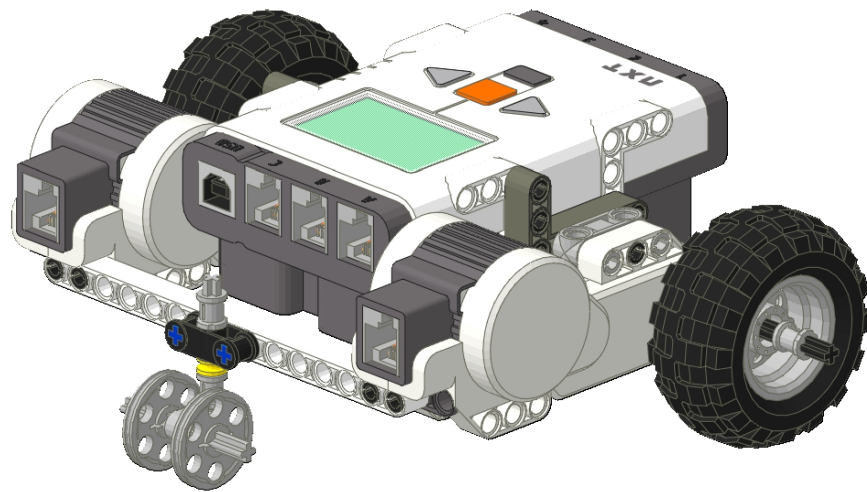

---

# Domabot - Base

Design by Damien Kee - [www.damienkee.com](http://www.damienkee.com)  
Teacher Resource Books - [www.domabotics.com/books](http://www.domabotics.com/books)



2x

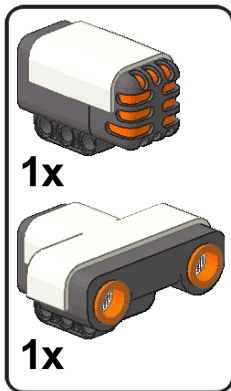
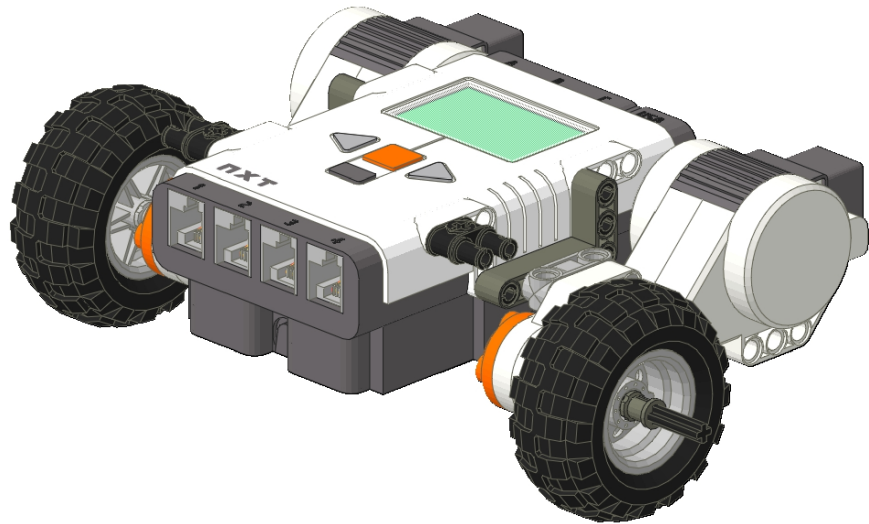

1x

1x

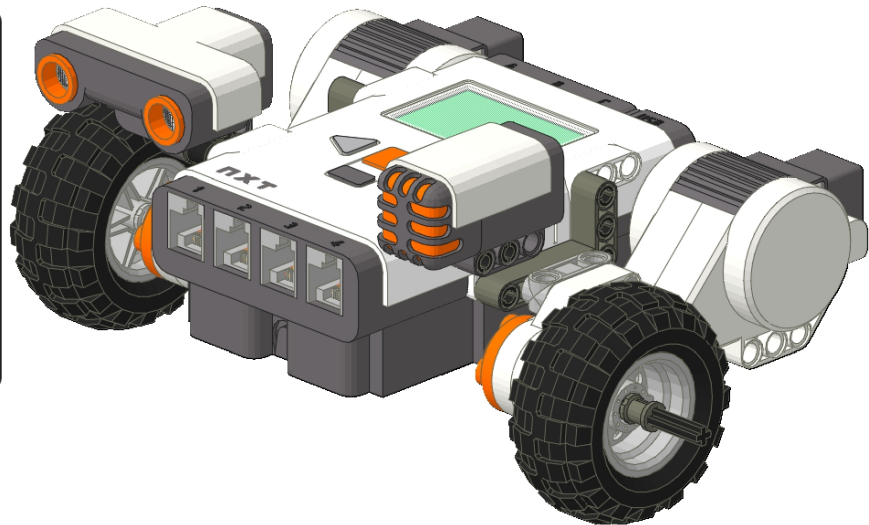

# Domabot - Base

Design by Damien Kee - [www.damienkee.com](http://www.damienkee.com)  
Teacher Resource Books - [www.domabotics.com/books](http://www.domabotics.com/books)

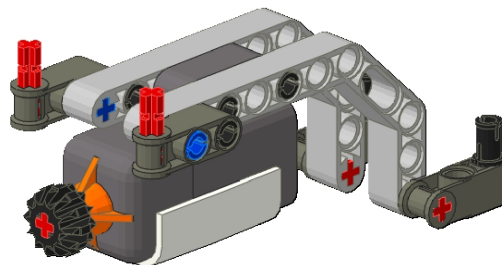
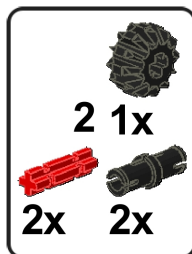
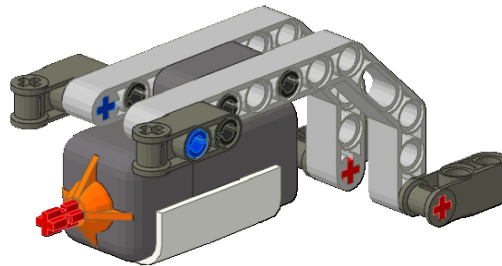
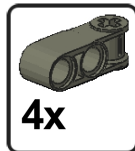
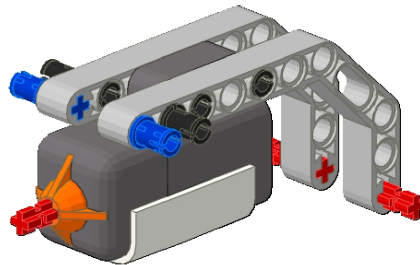
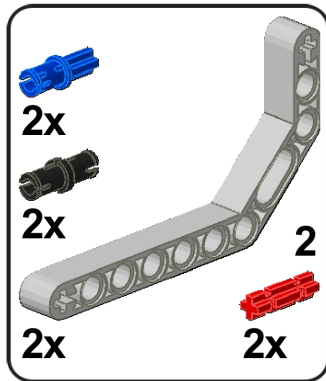
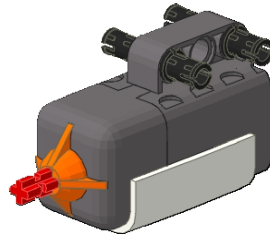
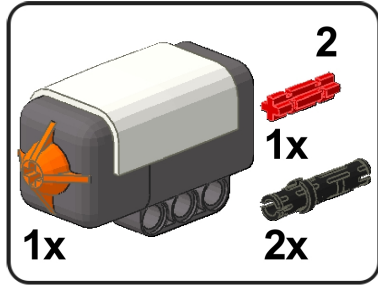

## Domabot - Touch Sensor Attachment

Design by Damien Kee - [www.damienkee.com](http://www.damienkee.com)  
 Teacher Resource Books - [www.domabotics.com/books](http://www.domabotics.com/books)

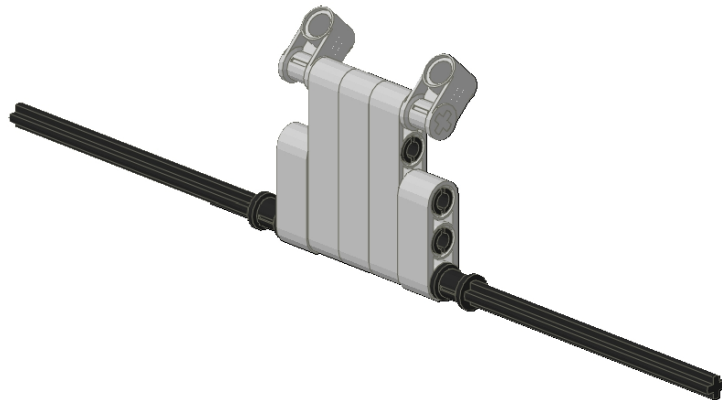
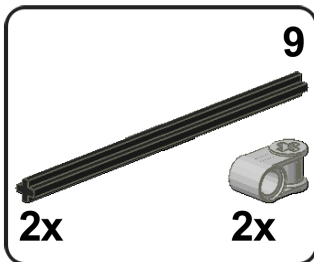
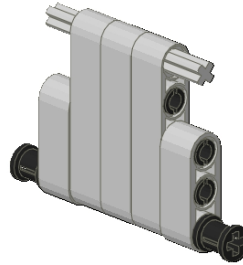
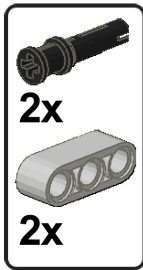
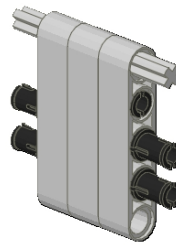
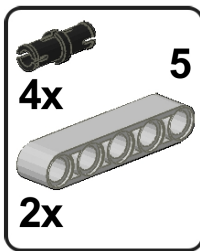
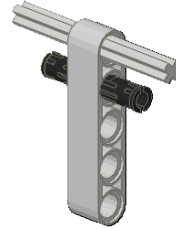
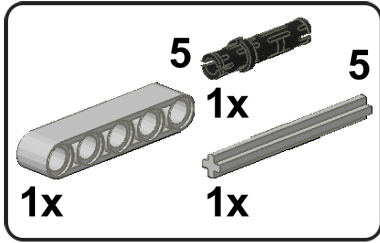

## Domabot - Touch Sensor Attachment

Design by Damien Kee - [www.damienkee.com](http://www.damienkee.com)  
 Teacher Resource Books - [www.domabotics.com/books](http://www.domabotics.com/books)



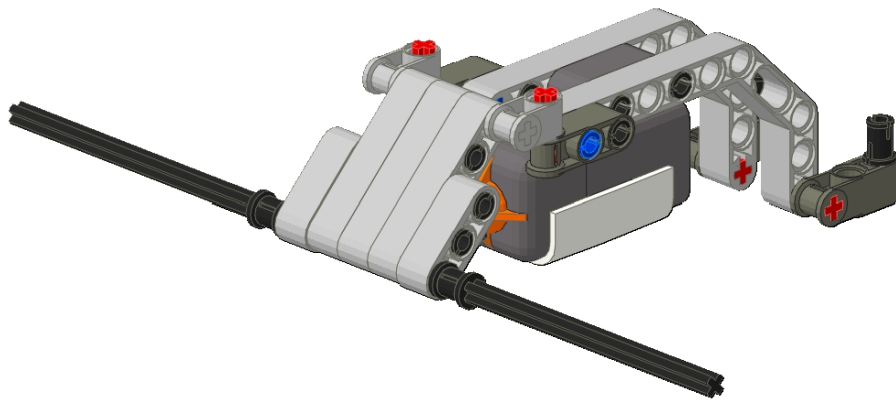

---

## Domabot - Touch Sensor Attachment

Design by Damien Kee - [www.damienkee.com](http://www.damienkee.com)  
Teacher Resource Books - [www.domabotics.com/books](http://www.domabotics.com/books)

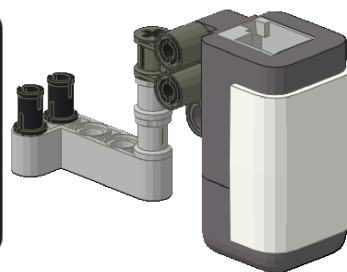
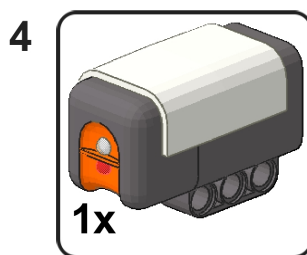
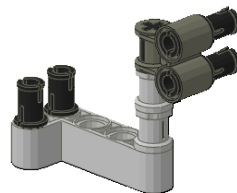
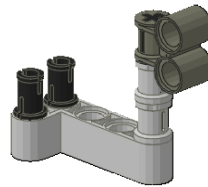
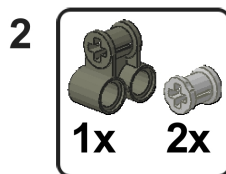
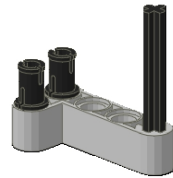
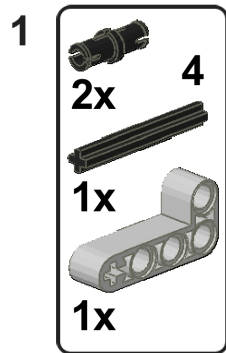

---

## Domabot - Light Sensor Attachment

Design by Damien Kee - [www.damienkee.com](http://www.damienkee.com)  
Teacher Resource Books - [www.domabotics.com/books](http://www.domabotics.com/books)

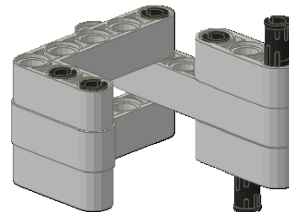
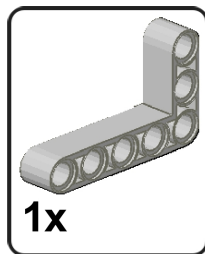
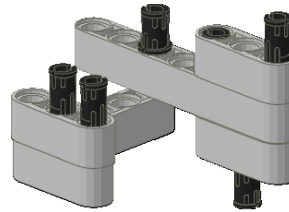
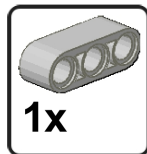
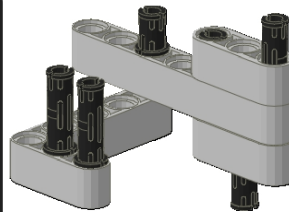
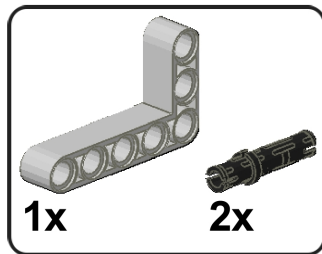
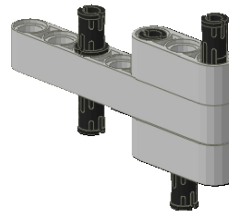
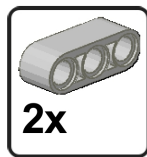
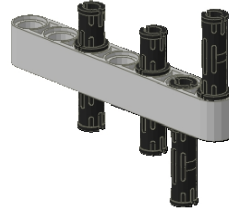
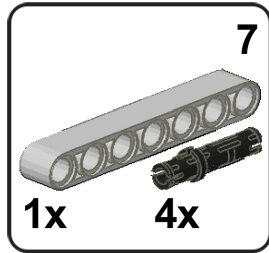

---

## Domabot - Pen Attachment

Design by Damien Kee - [www.damienkee.com](http://www.damienkee.com)  
Teacher Resource Books - [www.domabotics.com/books](http://www.domabotics.com/books)

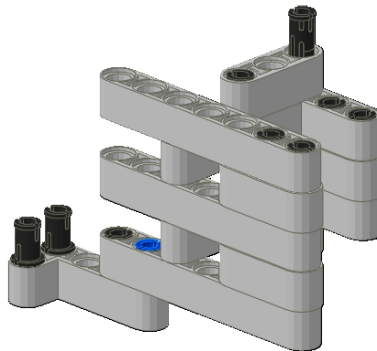
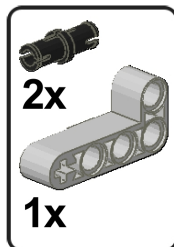
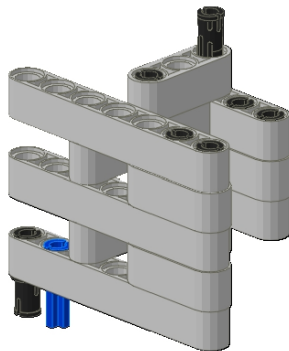
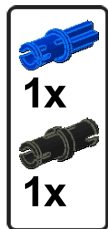
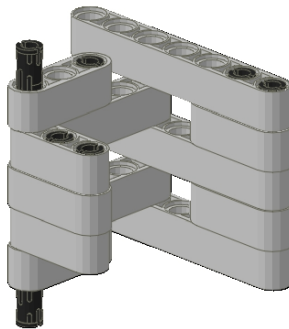
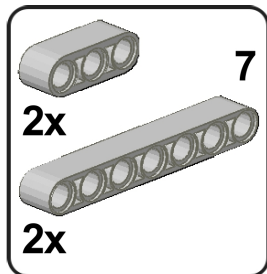
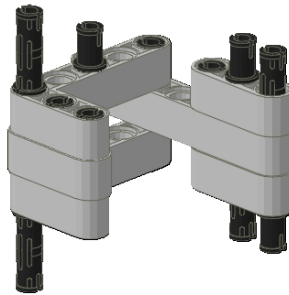
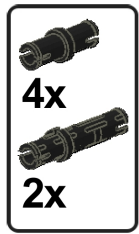

## Domabot - Pen Attachment

Design by Damien Kee - [www.damienkee.com](http://www.damienkee.com)  
Teacher Resource Books - [www.domabotics.com/books](http://www.domabotics.com/books)